

LED Downlight Leto 12W Manual

Item:8719157050678 & 8719157050685

Cautions :

1. Make sure the power stay on power " OFF " position before safe operation ;
2. The installation operator must hold a qualified electrician certificate ;
3. Check the lighting fixture and accessories before installation . If there is any damage in lamp body or glass , please stop the installation .

Product Parameter :

Series Name : LED Recessed Downlight
Dimension:Ø165*86mm
Cutter size: Ø140mm
Input Voltage : AC 220~240V 50/60Hz
Power Max. : 12W
Driver : outside Driver
Material : Aluminium Alloy Body

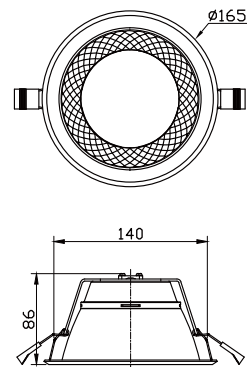

Installation Step :

1. Cutting a Ø140mm hole on the ceiling.

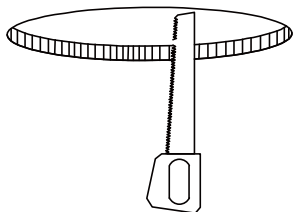

2. Connect driver with power and put into ceiling.

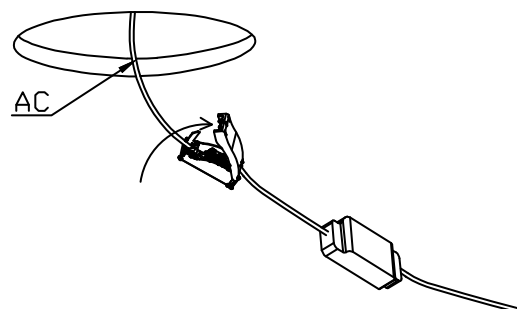

3. Connect male and female connector and lock tightly.

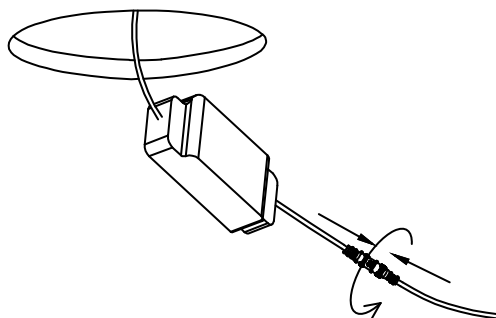

4. Press two springs and put the lamp fixated with ceiling

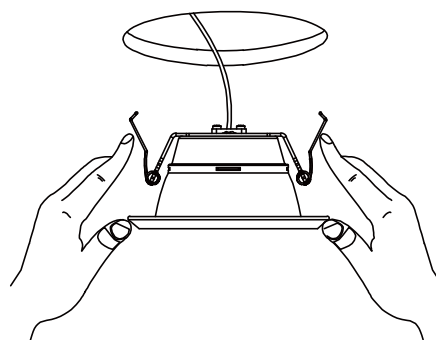

5. Complete.



Luminaires not suitable for covering with thermally insulating material

